

1010204

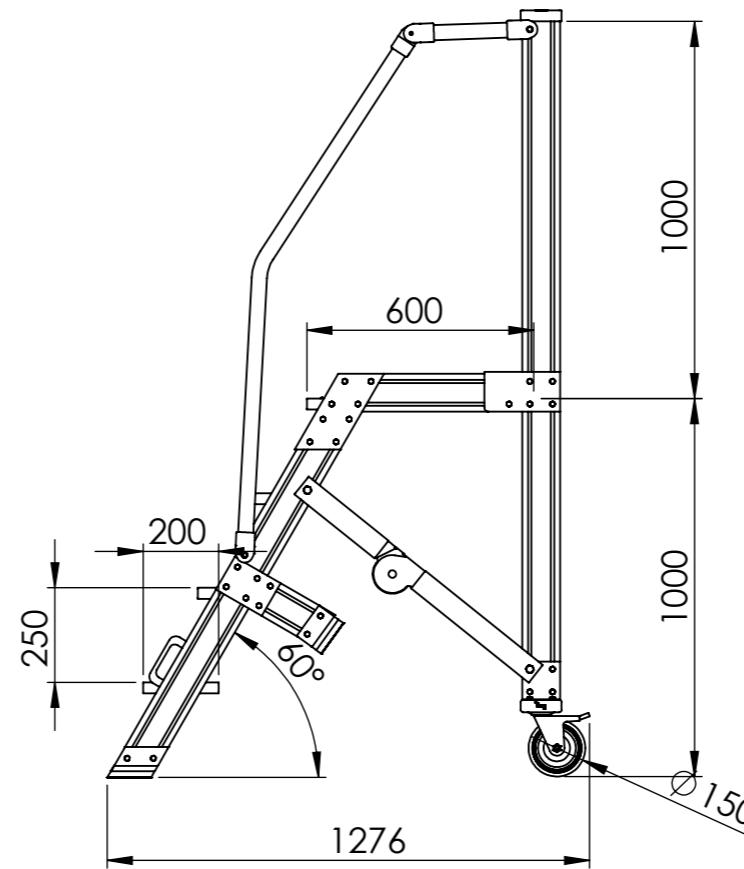
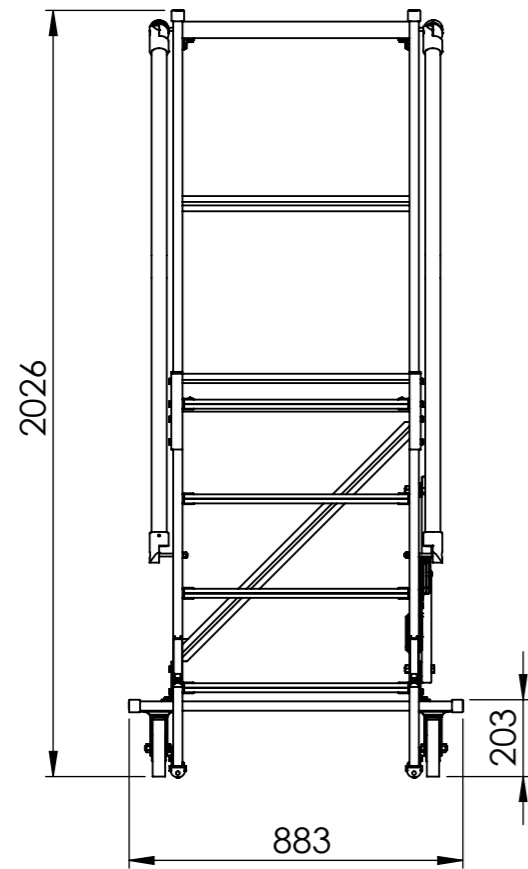
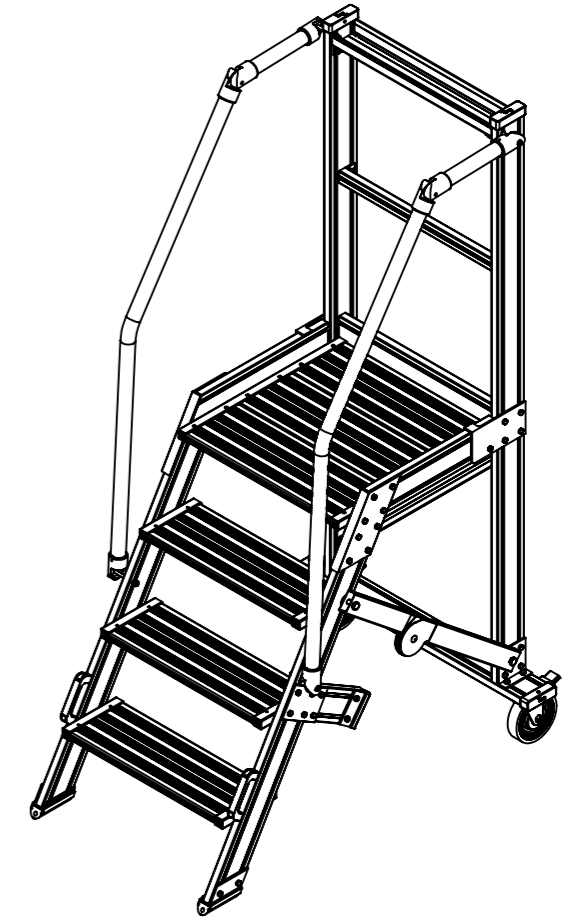
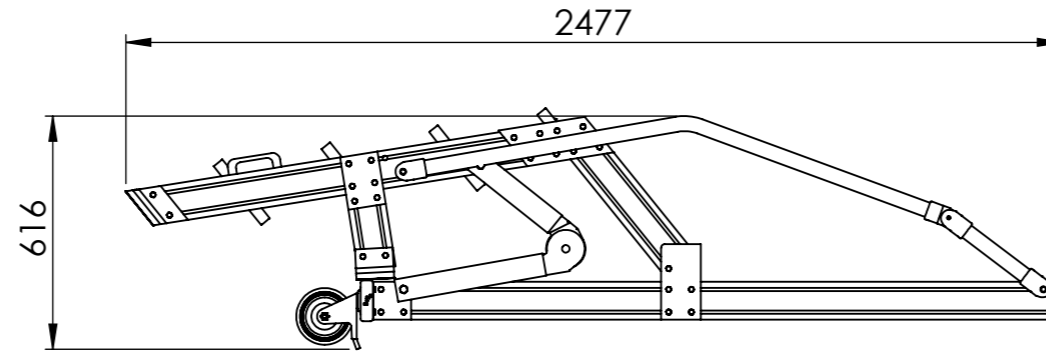
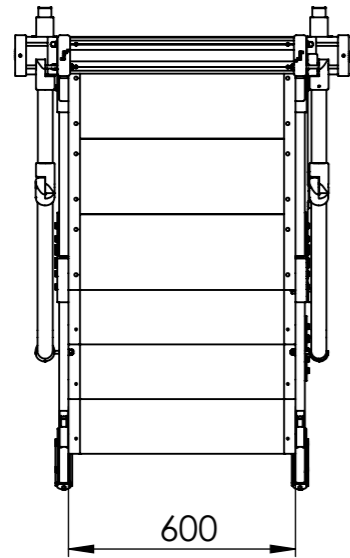

32 kg

ESLA