

1060305

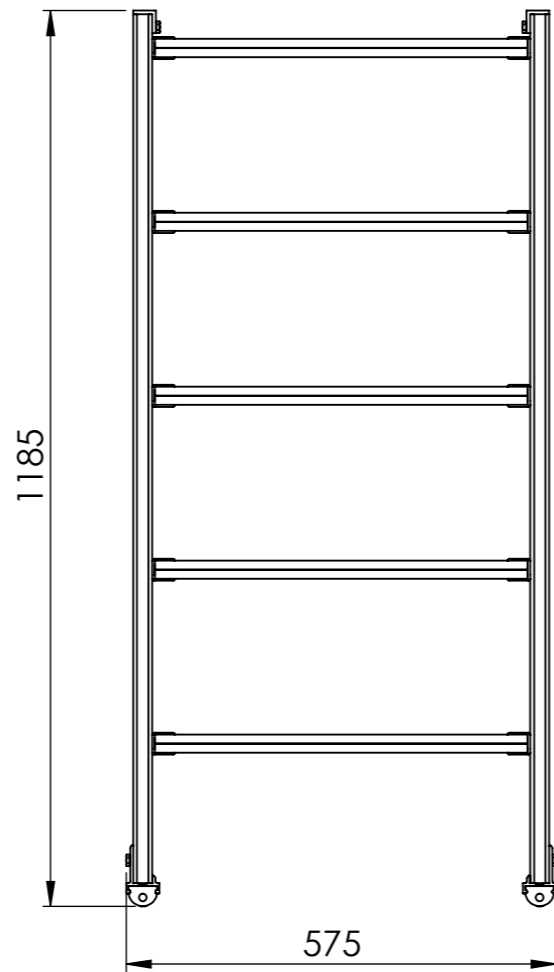
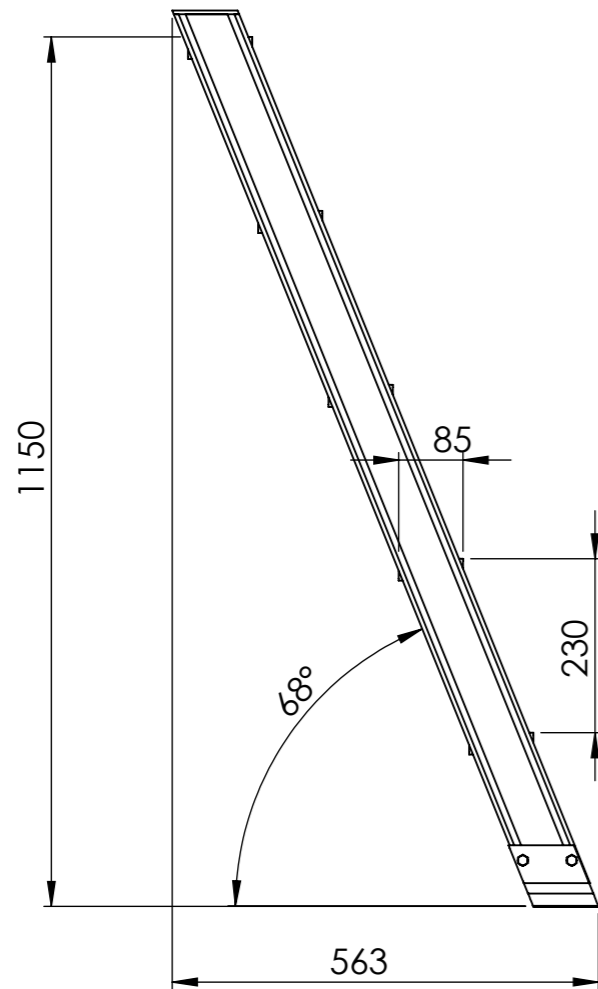
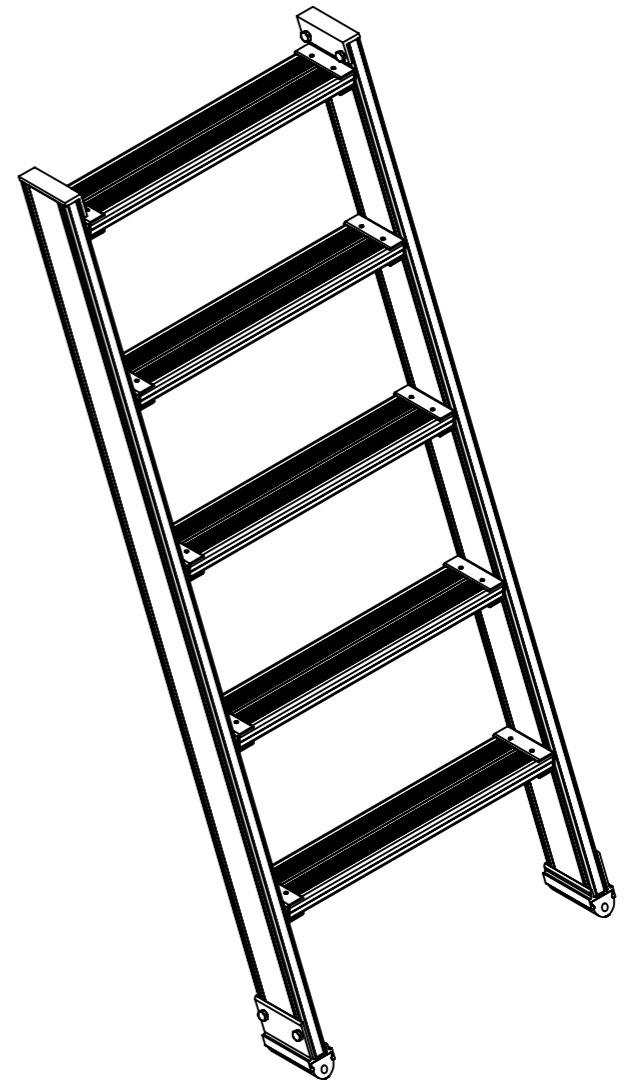
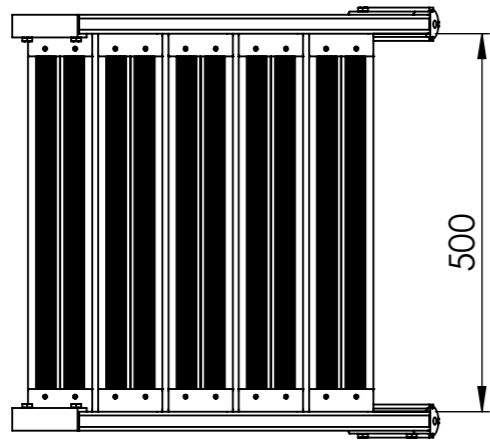

6 kg

ESLA